

**TUNNEL ECO**  
**BASE**

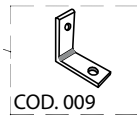

**TUNNEL ECO  
MOBILE**

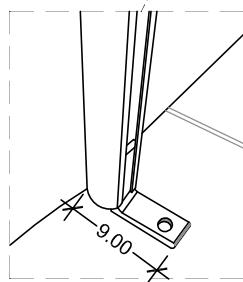
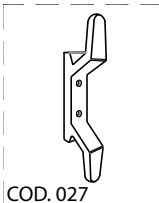
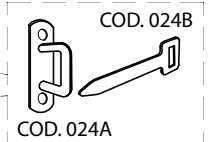
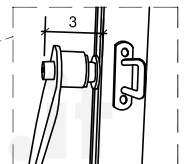
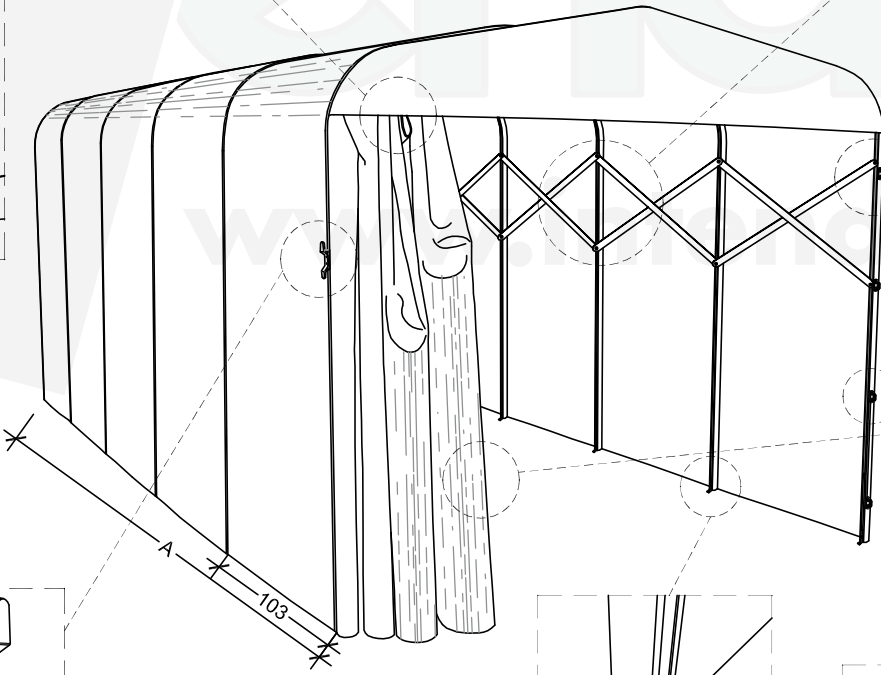
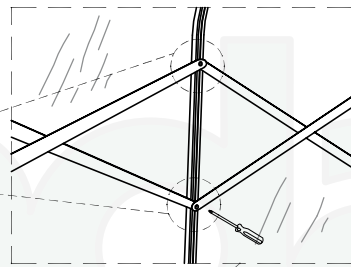
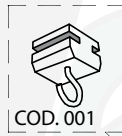
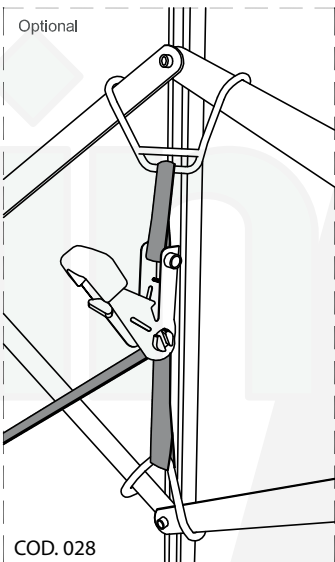
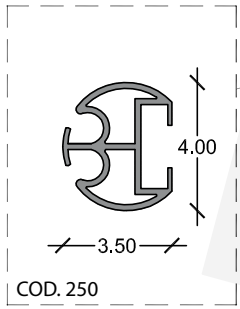
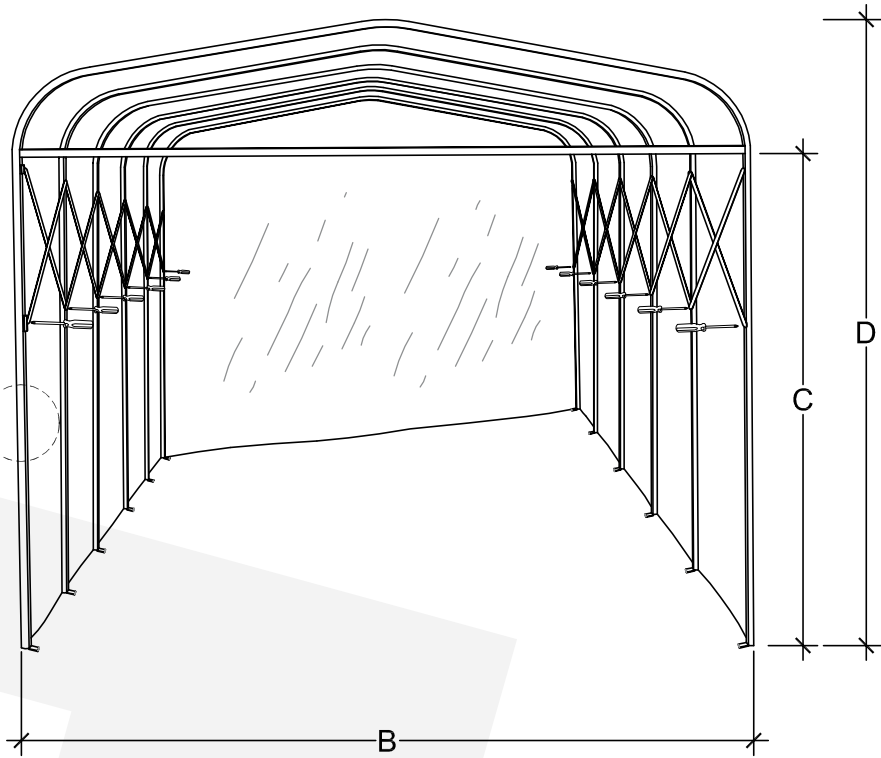
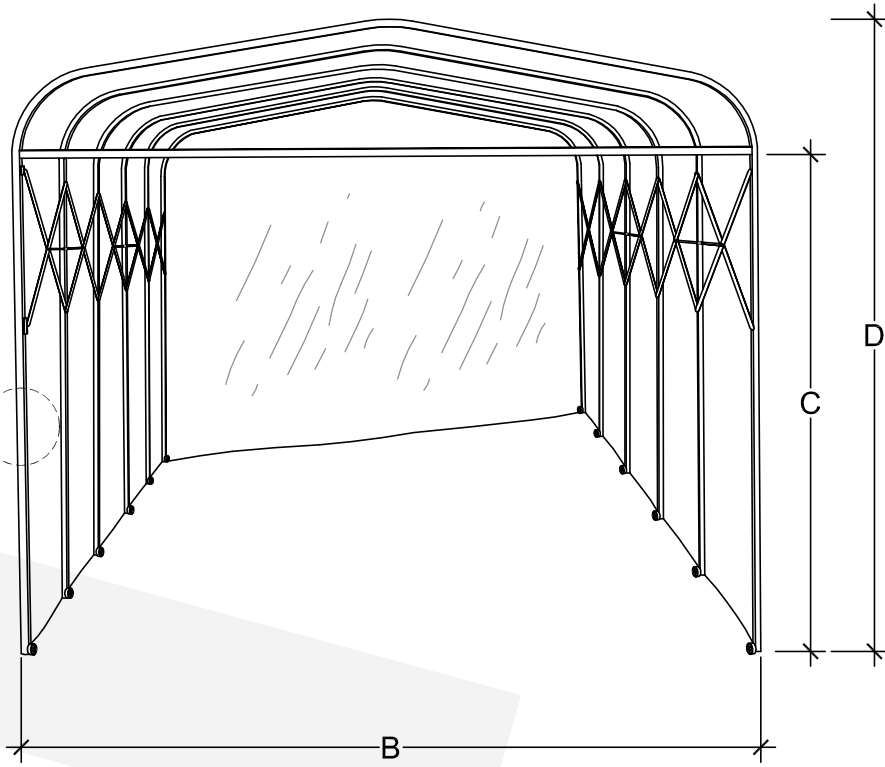
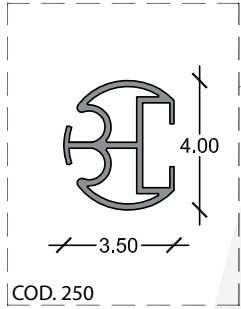

Moduli  $\neq$  cm 103



A > 700 cm

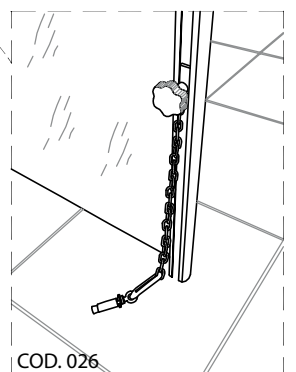
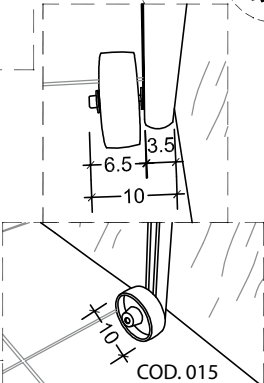
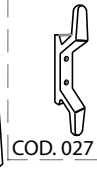
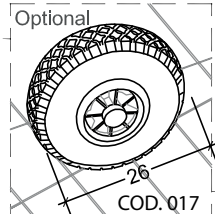
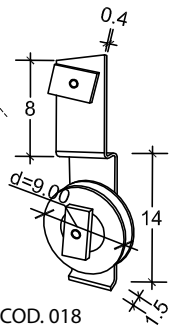
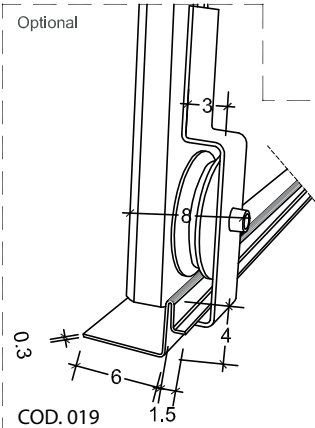
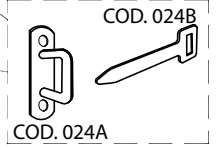
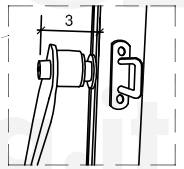
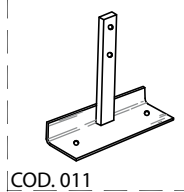
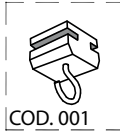
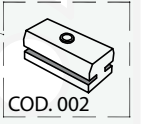
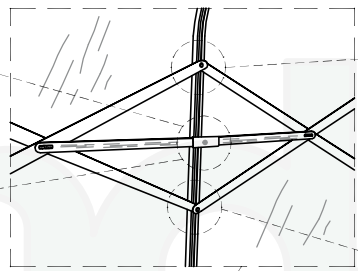
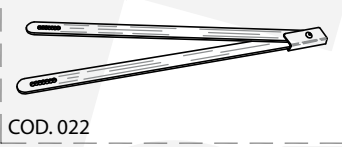
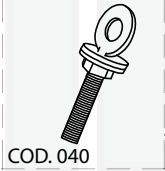

**TUNNEL BASE**

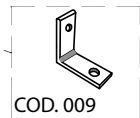
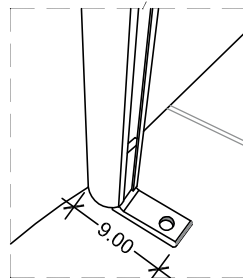
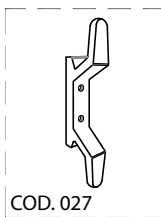
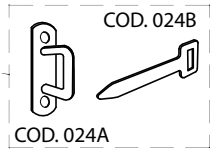
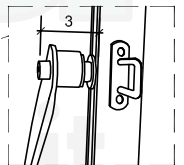
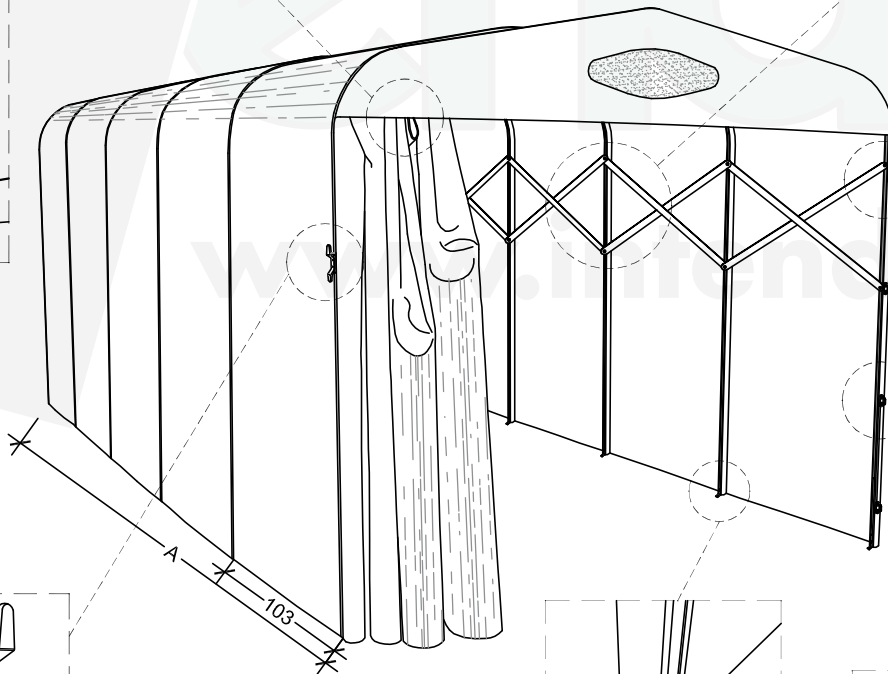
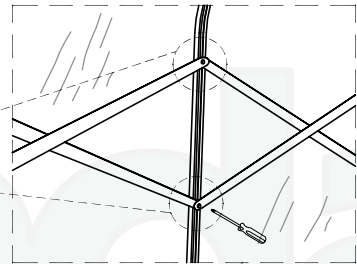
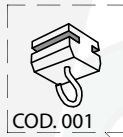
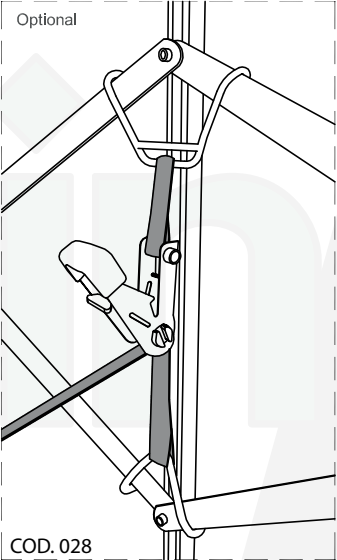
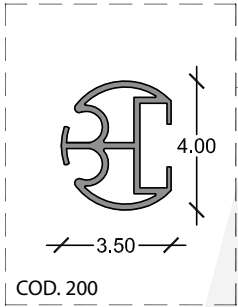
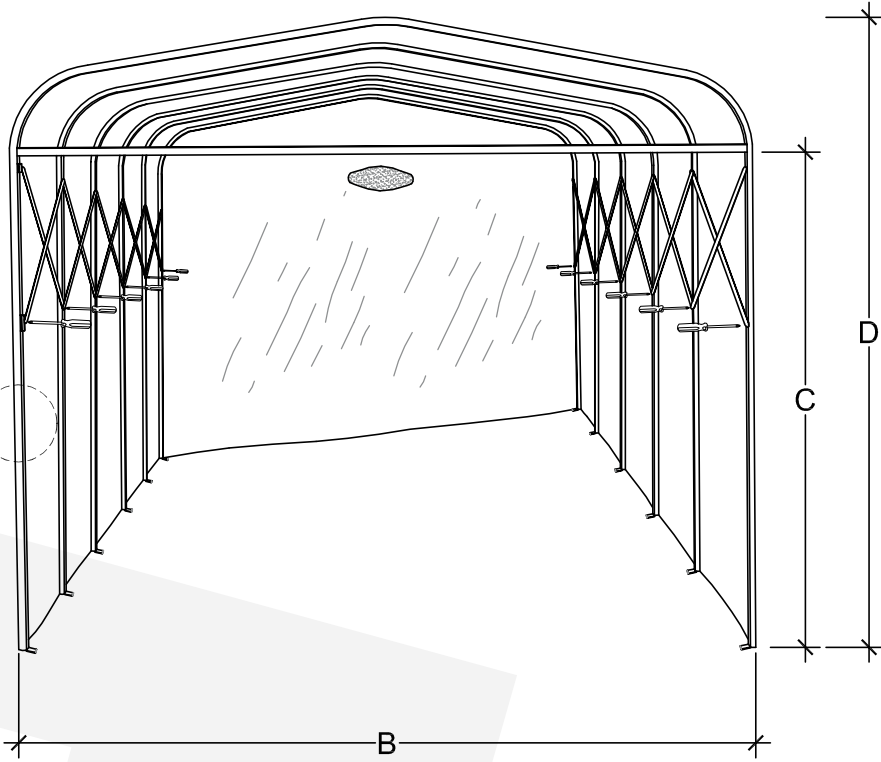

**TUNNEL MOBILE**

